



Aero **Systems** West™

Aircraft Handbook

Table of Contents

Important Notice to Operators	4
Foreword	5
What's In The Box	6
Limited Warranty	7
Disclaimers, Terms, & Conditions	8-9
NDA Compliance	10
Customer Registration	11
Setup & Equipment	13
Ardupilot - Introduction	15
Default Hand Controller - Setup	16-19
Battery Charging & Care	21
Customer Payload Mounting - Rails	23
Customer Payload Mounting - Frames	25
Remote ID - Operator ID	27
Remote ID - LED Indicators	29
Operations & Preflight Checklists	31
Mission Planning - Basic Information	32-34
Emergency Procedures	35
In Shop - Preflight Checklist	37
Assembly - Preflight Checklist	39
Pre-Launch & Launch - Preflight Checklists	41-45

Specs & Maintenance	47
ILM Legacy Multirotor	49
HLM Multirotors	51-55
Maintenance Intervals - All Aircraft	57

Supplements	59
HereLink	61
Radio Control System	63
Daughterboards	65
Resources - Arducopter (Software)	67
Resources - CubePilot (Hardware)	69
Resources - Mission Planner (GCS)	71
Resources - Aero Systems West (ASW)	73
Admin - Version Control	75
Contact - ASW General Support	77

Aircraft Handbook Identification:

- Owner: _____
- Aircraft S/N: _____
- FAA Registration: _____
- Return If Found: _____

- Phone: _____

Important Notice to Operators

Thank you for choosing an Aero Systems West aircraft.

Please be aware that by operating this aircraft, you are agreeing to certain Disclaimers, Terms, and Conditions that apply to its use. These terms outline your responsibilities as the operator, including compliance with all laws and safe operation of the aircraft.

Operating the aircraft means you accept these terms.

For the complete Disclaimers, Terms, and Conditions, please see page **8 and 9** of this handbook.

Foreword

Thank you for choosing our system. As engineers, we take great pride in designing equipment that not only meets technical requirements but also supports you in the field. This handbook was created as a quick reference to help you operate and maintain your system with confidence.

For more in-depth details, troubleshooting steps, or expanded specifications, we encourage you to review the additional guide available on our website. There, you'll always find the most up-to-date documentation, along with additional resources to support your work.

We appreciate your trust in our engineering and hope this tool serves you well.

– The Engineering Team - Your Mission, Our Lift™

What's In The Box

Every ASW drone is shipped in a heavy-duty, foam-lined freight case designed to protect the aircraft and included components during transport and storage. Inside the case, you will find the following standard items:

Core Components:

- Drone frame
- Landing gear (x4)
- Arms (variant dependent)
- Arm assembly hardware (plus spares)

Tools and Assembly Accessories:

- Hex driver for installing and removing arms and landing gear
- Hex driver for securing the three-phase motor power connections
- USB cable for flight controller and remote-ID access

Ground Control Equipment:

- USB hand controller
- Ground control modem with antennas and USB cable; pre-configured and paired to your drone for command-and-control link

Power System:

- Primary Flight Batteries (1 Set) – Standard or High-Capacity as specified by your order. *Note: battery chargers are not included but available separately.*

Payload-Dependent Items:

If ASW performed a custom payload integration for your order, your case may include additional or different components such as:

- Integrated payloads components
- Payload mounting accessories
- Alternate hand controllers
- Alternate modems or communication accessories
- Variant-specific or mission-specific cabling

Your order documentation will specify any custom components included with your system.

Limited Warranty

1. Coverage

Aero Systems West, Inc. ("ASW") warrants to the original purchaser ("Customer") that any unmanned aircraft system ("Product") manufactured by ASW will, for a period of one (1) year from the date of purchase, operate in substantial conformance with the documentation provided with the Product and be free from material defects in workmanship.

2. Scope and Limitations

This Limited Warranty applies only to Products manufactured by ASW. It does not extend to payloads, components, or accessories supplied by third parties, whether or not installed or integrated by ASW, except that ASW warrants only the quality of its own installation services to the extent expressly set forth herein.

3. Exclusions

This Limited Warranty does not cover:

- Products that have been abused, misused, altered, neglected, or damaged after delivery.
- Products damaged in transport or subjected to unauthorized repair, maintenance, or installation, as determined by ASW.
- Third-party payloads, software, or components, including their design, performance, safety, or reliability.
- Software provided with the Product, which is supplied "as is."

4. Claims Procedure

To make a warranty claim, Customer must notify ASW before the expiration of the warranty period and obtain a Return Material Authorization (RMA) number. Products must be shipped freight prepaid, insured, securely packaged, and marked with the RMA number on the exterior of the package and any accompanying documentation. A written description of the defect must accompany the return.

5. Remedies

At its sole discretion, ASW will either repair the Product, replace the Product, or refund the original purchase price paid by Customer. These remedies are Customer's sole and exclusive remedies under this Limited Warranty.

6. Limitations of Liability

To the maximum extent permitted by law, ASW's total liability under this Limited Warranty shall not exceed the actual purchase price paid for the defective Product. In no event shall ASW be liable for any indirect, incidental, consequential, punitive, or special damages, including but not limited to lost profits, business interruption, or substitute product costs, even if ASW has been advised of the possibility of such damages.

7. Implied Warranties (California Compliance)

To the extent required by applicable law, any implied warranties, including but not limited to the implied warranty of merchantability, are limited in duration to the same one (1) year period as this express Limited Warranty. Some states do not allow limitations on the duration of implied warranties, so this limitation may not apply to you.

8. High-Risk Applications

The Product is not designed or intended for use in high-risk applications, including but not limited to aviation navigation, nuclear facilities, life-support, or weapons systems. ASW disclaims all liability for such uses.

Company: Aero Systems West, Inc.

Address: 13025 Murphy Avenue, San Martin, CA 95046

Phone: 408-599-2791

Disclaimers, Terms, & Conditions

Acceptance by Use

By purchasing, operating, or otherwise using any unmanned aircraft system ("UAS") manufactured or supplied by Aero Systems West, Inc. ("ASW"), you ("Customer" or "Operator") acknowledge and agree to be bound by these Disclaimers, Terms, and Conditions. If you do not agree, you must not operate or permit the operation of the aircraft. Operation of the aircraft constitutes acceptance of these terms.

1. Regulatory Compliance & Operator Responsibility

1.1 Sole Responsibility of Operator: Under applicable U.S. law and international aviation principles, the operator of any aircraft (including UAS) is solely responsible for the safe conduct of flight and compliance with all federal, state, and local laws, regulations, and directives.

1.2 No OEM Certification Guarantee: Except as explicitly stated, ASW does not represent or warrant that any system is pre-certified, type-certified, or airworthy-certified for any particular use. All certifications, waivers, authorizations, or operational approvals must be obtained by the operator. Customers may contact ASW for in-depth information on how certification processes function in the United States.

1.3 International Operations: For customers outside the United States, the operator is solely responsible for compliance with applicable local laws and regulations. Operators should contact ASW for information or guidance specific to their jurisdiction.

2. Limitations of Liability

2.1 No Liability for Operations: ASW disclaims all liability for any loss, injury, damage, or penalty arising from or related to the operation, misuse, or modification of its UAS products, including but not limited to property damage, bodily injury, regulatory penalties, or loss of data.

2.2 Payloads and Modifications: The operator is solely responsible for the selection, integration, and operation of any payloads, modifications, or third-party components not provided and installed by ASW. Where ASW performs integration services at the customer's request, ASW warrants only the workmanship of its installation to the extent set forth in ASW's applicable written warranty. ASW makes no representation or warranty, express or implied, regarding the design, manufacture, performance, safety, or reliability of any third-party payloads or components, and expressly disclaims all liability for their use, failure, or integration. To the maximum extent permitted by law, ASW shall not be liable for any direct, indirect, incidental, or consequential damages arising out of or related to the use, failure, or malfunction of third-party payloads, regardless of whether installed by ASW or others.

2.3 Consequential Damages: To the fullest extent permitted by law, ASW shall not be liable for consequential, incidental, indirect, punitive, or special damages, even if ASW has been advised of the possibility of such damages.

Disclaimers, Terms, & Conditions – Cont.

3. Assumption of Risk

3.1 Inherent Risks: Operating unmanned aircraft systems carries inherent risks, including but not limited to collision, crash, interference, data loss, and injury. By using the aircraft, the operator voluntarily assumes all such risks.

3.2 Insurance: ASW strongly recommends that operators obtain adequate aviation liability and hull insurance coverage before operating any UAS.

4. Product Use & Restrictions

4.1 Non-Recreational Use: ASW UAS products are designed and sold for professional, commercial, academic, and governmental applications. They are not recreational consumer products.

4.2 Prohibited Uses: The aircraft shall not be used in any unlawful manner, including but not limited to: (a) carriage of hazardous materials, (b) surveillance or operations that violate privacy rights, or (c) applications restricted by applicable laws.

4.3 Export Controls: Export control obligations, if any, are determined by the final configuration of the aircraft, including payloads and modifications selected by the customer. The operator is solely responsible for ensuring compliance with all applicable export control laws and restrictions.

5. Indemnification

Customer agrees to indemnify, defend, and hold harmless ASW, its officers, employees, contractors, and affiliates from any claims, liabilities, damages, losses, costs, or expenses (including reasonable attorneys' fees) arising out of or related to:

- (a) Customer's operation of the UAS,
- (b) any modification or payload integration,
- (c) failure to comply with applicable law, or
- (d) breach of these Terms and Conditions.

6. Governing Law & Dispute Resolution

6.1 Governing Law: These Terms and Conditions shall be governed by and construed under the laws of the State of California, without regard to its conflict-of-law principles.

6.2 Venue: Any disputes shall be resolved exclusively in the state or federal courts located in Santa Clara County, California, unless ASW elects arbitration under applicable rules.

6.3 Severability: If any provision is held invalid, the remainder shall remain in full force and effect.

7. Updates to Terms

ASW reserves the right to modify or update these Disclaimers, Terms, and Conditions at any time. Continued use of the UAS after notice of updates shall constitute acceptance of the revised terms.

Company: Aero Systems West, Inc.

Address: 13025 Murphy Avenue, San Martin, CA 95046

Phone: 408-599-2791

NDAA Compliance

ASW designs and assembles its drones using components selected to comply with U.S. National Defense Authorization Act (NDAA) requirements that are in effect as of the date of shipment. In their default factory configuration, ASW drones are intended to be compliant with all UAS-relevant portions of the NDAA, including Section 889 and related prohibitions on certain covered telecommunications and video surveillance equipment. Unless otherwise specified in your order documentation, your drone is shipped in this default configuration, which uses components chosen by ASW to meet applicable NDAA restrictions for small UAS and excludes, to the best of ASW's knowledge and based on supplier representations, components known to be restricted under NDAA provisions in effect at that time. ASW does not guarantee that any drone will comply with future NDAA provisions or other laws or regulations that may be proposed, enacted, or amended after the shipment date.

Custom Configurations and Payload Integrations

Many customers request custom configurations, including but not limited to:

Custom payloads or integrated sensors

Alternate communication systems or modems

Third-party controllers, radios, or accessories

Customer-supplied hardware or software

Certain custom configurations or payload integrations may cause a particular aircraft not to meet NDAA requirements or other applicable regulations. Where ASW reasonably believes a requested configuration has the potential to impact NDAA compliance, this will be discussed with the customer during the sales process and/or reflected in the order documentation. However, any integration of customer-supplied equipment or any post-delivery modification made by the customer or a third party is outside ASW's control and may affect the compliance status of the system.

Customer Responsibility (Important Notice)

Regulatory obligations can vary based on the end user, operating organization, country, and mission profile. Laws and regulations, including the NDAA, may change over time. ASW does not provide legal advice and cannot guarantee that any drone configuration will meet all current or future legal, regulatory, or contractual requirements applicable to a specific user, program, or procurement. It is the customer's responsibility to determine whether their specific drone configuration (including any custom integration, modification, or accessory) complies with all laws, regulations, and contractual requirements that apply to them and their operations. Customers with compliance-sensitive missions (e.g., U.S. Government or defense-related programs) should review their specific requirements with their legal/compliance personnel and verify that their drone configuration is appropriate for those requirements.

Customer Registration

Registration is optional, and is not required for warranty coverage or access to ASW support. However, many owners choose to register their drone so we can associate a preferred email address with the aircraft's serial number. This allows ASW to contact you if there are important updates relevant to your specific system, such as recommended software updates, maintenance advisories, or recall notices.

If you would like to register your drone, simply send an email including your serial number(s) and preferred contact email(s) to **registration@aerosystemswest.com**

Registration information is used solely for product-related communications. It will not be used for promotional messaging, and it will not be sold, shared, or distributed to third parties. Registration is provided as a convenience only. ASW may use registration information to share relevant product information but does not guarantee notification in all circumstances. Customers remain responsible for staying informed about any updates, advisories, or requirements applicable to their operations.

We appreciate your purchase and look forward to supporting you throughout the life of your drone.

Setup & Equipment



Not all ASW aircraft ship with the same equipment. If applicable, additional reference can be found in the Supplements section.

This section provides an overview of our default equipment and software configurations for ASW ILM Legacy and HLM aircraft shipped after August 2025. For information on legacy aircraft prior to 2025 please visit our website at aerosystemswest.com/docs.

ArduPilot - Introduction



ASW is proud to be an official ArduPilot partner. All of our drones ship with genuine ArduCopter control software. As such, your new drone may be controlled by any ground control software offering that supports the MavLink control protocol. However, our official recommendation for control of your new drone is the Mission Planner Windows application. Mission Planner is a fully featured ground control station application making available to the user the full suite of capabilities supported by ASW drones.

Mission Planner Software

The most recent version of Mission Planner may be downloaded at: <https://firmware.ardupilot.org/Tools/MissionPlanner/>

Mission Planner Wiki

The wiki page for Mission Planner provides a detailed description of all available features and may be found at: <https://ardupilot.org/planner/index.html>

ASW strongly suggests customers familiarize themselves with Mission Planner, especially the Data and Plan tabs in order to maximize the probability of successful flight operations.

Furthermore, ASW offers remote or in-person training courses, tailored to each customer, if a deeper or more bespoke education is needed. Please contact us for more information. Training courses are subject to certain equipment restrictions and scheduling availability.

Please see [page 32](#) for more information on mission planning.

Default Hand Controller - Setup

ASW is proud to include the Fort Robotics™ IP67 rugged USB hand controller as the default controller for all manual operations of the drone.

Further information on the Fort hand controller may be found at the following QR code below. This includes advanced setup options and a full description of the safety and convenience features offered by this controller. For new installations of the Mission Planner ground control software, the hand controller will require a one-time setup and mapping procedure.

To import ASW's suggested settings:

Please navigate to aerosystemswest.com/docs/ to download the appropriate "joycfg" files. Launch Mission Planner and navigate to the Joystick window. Select Import then pick the appropriate joycfg file.

Note that ASW HLMs ship with the Fort Robotics NDAA compliant controller by default, but a file is also included for the Logitech(TM) F310 for reference. Once imported, select Save. One-time setup is now complete. For subsequent operations, connect your hand controller to your computer, power it on using the on/off button located on the front of the controller, launch Mission Planner, navigate to Joystick, and select Enable. You may then close the Joystick window and proceed with connecting to your drone.

To import ASW's suggested settings (legacy method):

Please navigate to aerosystemswest.com/docs/ to download the xml files (each controller option has two associated xml files). Do not rename these files. With Mission Planner closed, place both files in the folder located at ****yourComputerName** > Documents > Mission Planner**

Note: on some versions of Mission Planner it has been observed that Joystick functionality is not available until the software has been connected to a drone at least once. For this reason, ASW recommends connecting to your HLM prior to performing the legacy hand controller setup method.

For subsequent operations, connect the hand controller (be sure to power it on using the on/off button located on the front of the controller), launch Mission Planner, and navigate to the joystick window. It should be observed that all settings now match the graphic below. Please see [page 34](#) for further notes regarding flight modes. Select "Enable" to begin using your controller.

Default Hand Controller - Setup -Cont.

Fort Robotics™ Hand Controller ASW Default Mapping

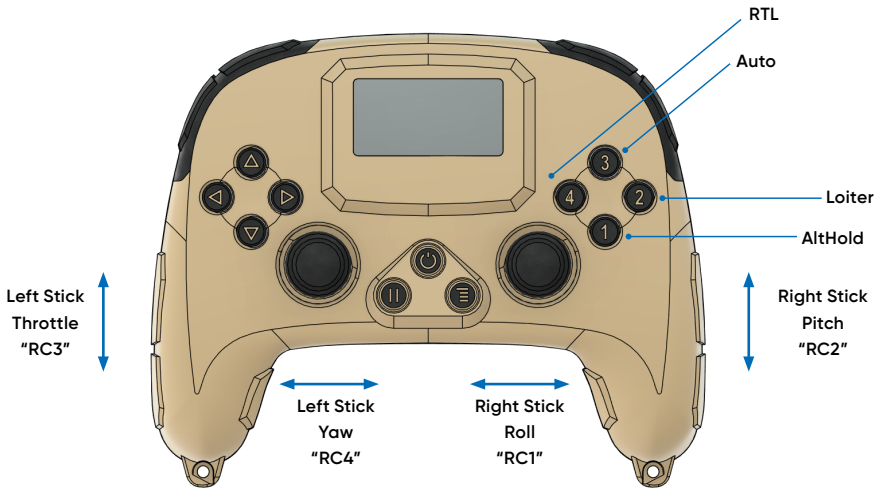

Scan the QR code to learn more about the Fort Robotics™ hand controller setup options and features.

Default Hand Controller - Setup - Cont.

To perform this manually:

Connect the USB hand controller to your Windows computer and press the power button. Launch Mission Planner and select "Joystick" in the actions sub tab.

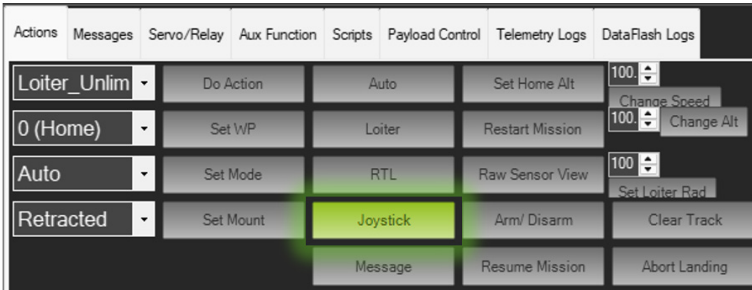

In the joystick window, select the hand controller from the dropdown. On most windows machines, this will be labeled "SRC Application." It will be necessary to map mode buttons on the right as well as RC1 through RC4 on the left by selecting "Detect" for each one, pressing Okay, then moving the corresponding stick. If your HLM utilizes the USB controller for any payload control, it may also be necessary to map the two forward rockers to Ch7 and Ch8.

Please see the graphic below for which stick corresponds to which RC input. Please note that the "Reverse" box must be checked for RC3. Next, Buttons 1 through 4 should be mapped to mode changes. For each button, select "Detect," press Okay, then push the corresponding button on the controller. For all four, select "ChangeMode" from the dropdown, press Settings, then select the mode corresponding to the graphic below. When done, the Joystick window should match the graphic below. Press Save then you are done with initial setup.

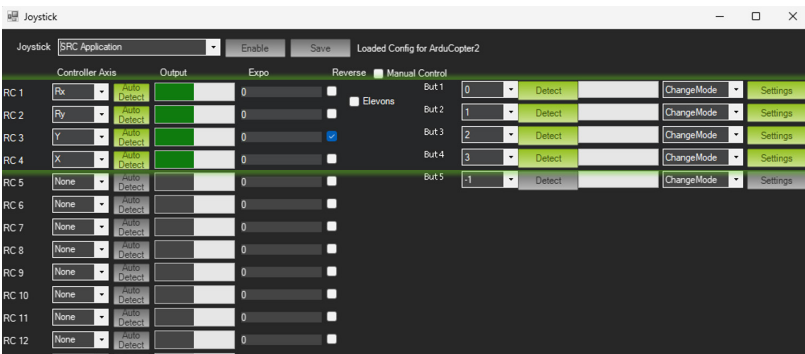

Default Hand Controller - Setup - Cont.

Mapping and setup are not required for subsequent uses of the system. Simply navigate to the joystick window and select Enable at the appropriate step in your preflight setup.

For advanced options regarding hand controller integration with the Ardupilot software, please visit the community wiki page at:

ardupilot.org/copter/docs/common-joystick.html



Please note that this workflow will apply when setting up alternative USB hand controllers, for example the LOGITECH® F310 controller, however the graphics in this handbook may not apply and NDAA compliance may be adversely affected. Please confirm all functionality and checklists if using an alternate USB hand controller.

Battery Charging & Care

ASW drones use high-energy 12-cell (12S) lithium-polymer batteries. Standard packs are 23 Ah, and High-Capacity packs are 35 Ah. Quad and Hex variants use two packs; Octo variants use four. Because lithium batteries contain significant stored energy, proper charging and storage are essential for safety and for maintaining battery health.

Charging Guidelines:

- Always use a smart charger designed for lithium-polymer (LiPo) batteries
- Balance-charge every time. This helps maintain pack health.
- Charge at no more than 1C (1 × pack capacity in amps). Many chargers will be limited below this rate, which is acceptable.
- Confirm the correct cell count (12S) and battery chemistry before starting the charge.
- Connect charger leads to the charger first, then connect the battery.
- When charging is complete, disconnect the battery first, then turn off the charger.
- Never leave batteries charging unattended.

Storage and Long-Term Care:

- Batteries should not remain fully charged for extended periods. If a charged battery is not used within one week, return it to storage voltage (~3.75 V per cell).
- Packs stored for more than 3–6 months should be cycled (one discharge/charge) to maintain performance. This can be done via a controlled shop discharge or a partial flight followed by a return to storage.
- Store batteries in a cool, dry place away from flammable materials, using a fire-resistant container when possible.
- Do not store batteries in a fully discharged state.

Handling and Safety:

- Inspect batteries before and after use. Do not use any pack that is punctured or crushed.
- Do not use packs that have fallen below 3.0 V per cell, exceeded 4.2 V per cell, been shorted, or no longer hold a normal charge.
- Avoid dropping or crushing the packs. Prevent any contact between the battery terminals and conductive materials.
- Allow batteries to cool after flight before charging.
- Transport batteries in a manner that prevents puncture or crushing.

General Notes

Proper battery care improves performance and extends service life. However, all lithium batteries degrade over time, and operating conditions vary widely. Customers are responsible for ensuring their charging equipment, procedures, and storage practices meet the safety requirements applicable to their operations. Customers may contact ASW with any questions regarding battery use or for recommendations on appropriate chargers.

Customer Payload Mounting - Rails

For additional mission flexibility, ASW offers a bolt-on payload rail mounting system (**sold separately**).

The rail kit fits all HLM variants and can be installed in a wide (10 in) or narrow (6 in) configuration. Additionally, users can configure the rail bracket positions to best suit their needs. When payload weight is evenly distributed between both rails, the system is rated to the full published payload capacity of all HLM variants. Rails are 1 in (25 mm) diameter, accommodating a host of aftermarket options. ASW also offers anodized aluminum tube clamps for integration with the rails and blank 3mm carbon fiber plates in large (12x14 in) and small (8x12 in) sizes. Each plate comes equipped with one set of 4 tube clamps and pre-machined mounting holes. For complex cases, ASW custom engineering can design and fabricate specialized plates and bracketry. Please inquire for available services.

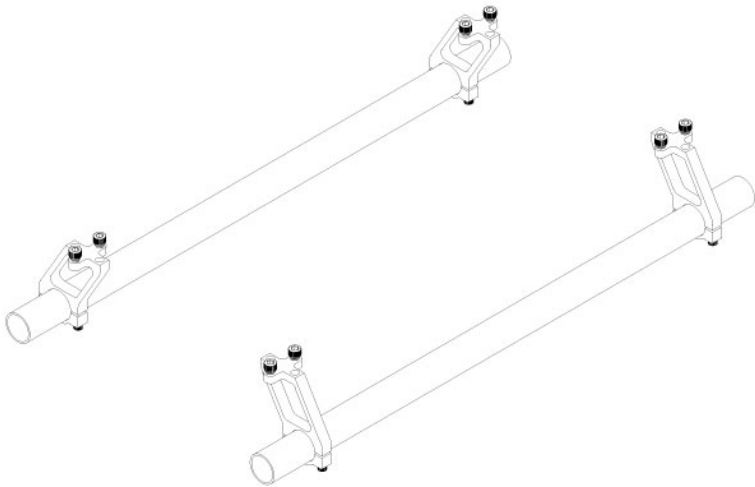

Download the full payload mounting rail spec sheet and up to date references at our website at aerosystemswest.com/docs or scan the QR Code.

Customer Payload Mounting - Frames

ASW manufactures three variants of the Heavy Lift Multirotor, indicated below. Two common mounting patterns are fabricated into all three lower frame variants for flexible integration of customer payloads. These patterns can accommodate various customer requirements (cameras, gimbals, lidar, multi spectral offerings, winch mechanisms, payload release options, dispense systems, and many more) via direct-mount or through an adapter plate. Please inquire for custom design services.

1. Inner Slot Pattern (Small)

- 4 slots total - 2 per side, aligned longitudinally
- Slot size: 0.154 in wide x 1.000 in long for SAE #6 hardware
- Center-to-center spacing: 6.000 in width, 4.000 in longitudinal
- Overall span: 5.000 in

2. Outer Slot Pattern (Large)

- 10 slots total - 5 per side, aligned longitudinally
- Slot size: 0.260 in wide x 1.000 in long for SAE 1/4" hardware (or M6)
- Center-to-center spacing: 8.000 in width, 4.000 in longitudinal
- Overall span: 17.000 in

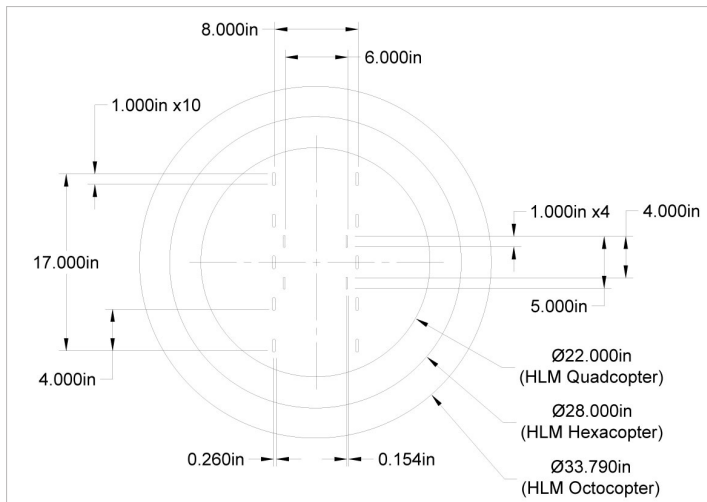

Download the full payload mounting frame spec sheet and up to date references at our website at aerosystemswest.com/docs or scan the QR Code.

Remote ID - Operator ID

Changing Operator ID:

All ASW HLM aircraft ship with a Remote ID transmitter compliant with 14 CFR Part 89. The transmitter is located at the left forward corner of the avionics carrier (Fig. 1). The Operator ID is factory programmed to "ASW_HLM_customer." It is the responsibility of the operator to update this ID in accordance with applicable regulations.

Operator ID is changed using the **ASW Remote ID Tool**, a free utility available at aerosystemswest.com/downloads. The tool currently requires a Windows computer. To update the Operator ID:

- Download and install the ASW Remote ID Tool from aerosystemswest.com/downloads
- Connect the drone's "RID USB" port to the computer using a standard USB-C or Micro-USB cable
- Launch the tool. The transmitter will be auto-detected and the current Operator ID displayed (Fig. 2)
- Edit the Operator ID field and click **Save to Device**
- Disconnect the USB cable. A power cycle is not required, but is recommended. The new value will be broadcast until such a change is made again.

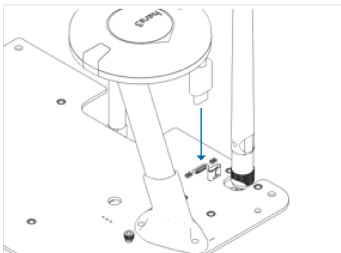

Fig. 1 – RID USB port location

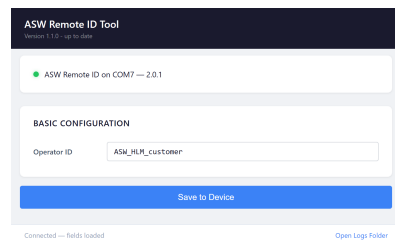

Fig. 2 – ASW Remote ID Tool

Remote ID - LED Indicators

The ASW Remote ID uses two LEDs (one red, one green) that may be viewed from underneath the drone to indicate the PFST status as well as the ongoing health of the unit, as needed. Indicators are as follows...

PFST Stage 1, Initial Boot

(Simultaneous Double Blink):

This indicates that the board has successfully booted, the transmitter has passed internal health checks, and all systems are operating within specifications.

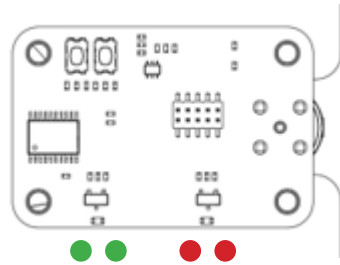

PFST Stage 2, Autopilot Data

Connection (Second Simultaneous Double Blink):

This indicates that the Remote ID has successfully begun communication with the autopilot and has begun requesting the data required for Remote ID broadcast.

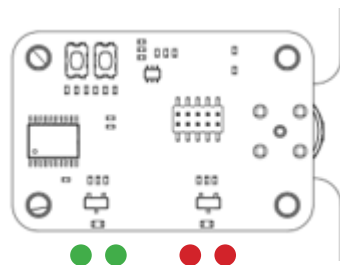

Ongoing Health, Ready to Arm:

Once the Remote ID unit has booted on, the green LED will blink once per second to indicate that the unit is healthy.

When the Remote ID unit is receiving all necessary data and is ready to allow autopilot arming, a solid red LED will also be displayed.

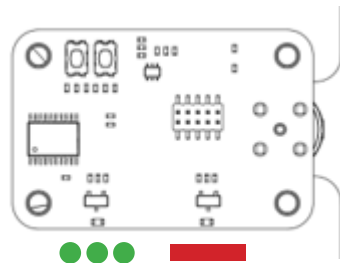



Operations & Preflight Checklists

Notes for your consideration:



Checklists are provided as a supplemental aid only and are not a substitute for training, certification, or regulatory knowledge. Operators are solely responsible for ensuring safe operations, airworthiness of the aircraft, familiarity with procedures, and compliance with all applicable laws and regulations.



All aircraft are factory-calibrated before delivery. Any changes to configuration, including payload installation or removal, may require recalibration. Operators who are not trained in calibration procedures should not attempt them and may contact ASW for available support options.



Unless customer exemption has been filed, all ASW aircraft ship with Remote ID transmitters per 14 C.F.R. Part 89 and remain compliant when operated from a static ground control location. Declarations of compliance are on file with the FAA and publicly available at <https://uasdoc.faa.gov/>

Mission Planning – Basic Information

ASW proudly ships drones with the CubePilot autopilot running the ArduPilot flight stack. Mission planning and autonomous flight are performed using Mission Planner, an open-source Ground Control Station (GCS) recommended for ASW systems. This section provides a brief quick-start overview for installing Mission Planner, connecting to your drone, understanding the main interface, and creating simple autonomous missions. For more advanced content, links and training options are provided at the end of this section.

Downloading and Installing Mission Planner

Mission Planner is available for Windows at:

<https://firmware.ardupilot.org/Tools/MissionPlanner/>

- Download the current stable release.
- Run the installer and allow USB/driver installation if prompted.
- Launch Mission Planner after installation is complete.



Connecting Mission Planner to Your Drone

ASW drones communicate over a paired telemetry modem included with your system.

- Power on your drone
- Plug the ground modem into your GCS computer
- In Mission Planner, use the “COM Port” dropdown (upper right) to select the port associated with the modem

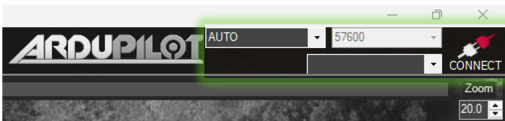

- Set baud rate to 57600
- Click Connect
- Mission Planner will sync parameters on first connection, which may take up to 30 seconds

Once connected, telemetry data will stream and the GCS will have command capability.



Note: ASW recommends **extreme caution** be exercised if using the Setup or Config tabs of Mission Planner. These provide detailed access to the settings of the drones and may yield unintended, potentially unsafe, results if altered by untrained personnel. Please contact ASW with any questions.

Mission Planning – Basic Information – Cont.

Mission Planner Interface Overview – The Data Tab

Heads-Up Display (HUD)

The HUD shows real-time aircraft attitude, altitude, ground speed, mode, GPS status, and battery data. It provides immediate situational awareness during both manual and autonomous flight.

Bottom-Left Action Panel

This panel provides quick-access controls:

- Mode Selector – Switch between flight modes (e.g., Loiter, Auto, RTL)
- Arm/Disarm – Commands motor arming and disarming
- Set WP (Waypoint) / Jump to WP – Allows selecting a specific waypoint for Auto mode
- Pre-arm checks and messages may appear here as well

Moving Map

The map displays the drone's location, flight path, mission waypoints, and home position. You can zoom, pan, and right-click for map tools. During Auto missions, waypoint progress is shown in real time.

Flight Modes Commonly Used With ASW Drones

ASW customers most frequently use the following ArduPilot modes, selectable through the Mode menu in the Data tab or with the hand controller:

- Loiter – GPS-stabilized hover; ideal for holding position
- AltHold – Maintains altitude but allows manual horizontal control
- Auto – Executes the uploaded mission plan
- RTL (Return-to-Launch) – Commands the drone to return to home and land
- Guided – Allows click-to-fly and ad-hoc repositioning from the GCS

Basic Mission Planning – The Plan Tab

Setting the Home Location

Home is the reference point for RTL and altitude calculations. In operations, Home will always be the location from which the drone is armed and launched. For planning purposes, Mission Planner allows setting a location manually or using the drone's GPS position when connected. If connected to the aircraft, click Home Location to set home to the drone's current GPS position. If offline, right-click the map select "Set Home Here."

Adding and Editing Waypoints

- Point-and-click on the map to add waypoints
- Adjust waypoint altitude in the Alt column or set a global default altitude
- Reorder waypoints using the arrow buttons

Mission Planning – Basic Information – Cont.

Key Waypoint Types for Most Missions

- Navigation commands (aircraft moves to a location):
 - » `takeoff` – Used for Auto takeoff (required by ASW drones to pass prearm checks)
 - » `waypoint` – Standard position command
 - » `loiter_unlim` – Hover indefinitely
 - » `loiter_time` – Hover for a fixed duration
 - » `return_to_launch` (RTL) – Return to home location and land
 - » `land` – Land at specific location
- Do-commands (non-navigation actions):
 - » `do_jump` – Jump to another waypoint to repeat patterns or skip sections
 - » `do_change_speed` – Adjust drone speed during the mission
- Writing and Reading Missions
 - » Write WPs uploads the current plan to the drone
 - » Read WPs downloads the plan currently stored on the drone
 - » Save/Load lets you store mission files for later reuse

Setup and Configuration Tabs

Setup Tab

This tab contains factory-level configuration options, firmware loading, and sensor setup. ASW drones are shipped fully configured; customers do not need this tab for normal operation. Modifying settings here may negatively affect flight safety.

Config Tab

Most configuration elements should remain unchanged. However, two areas may be useful:

- Planner Sub-Tab – Adjust Mission Planner’s interface preferences (units, voice prompts, themes, etc.)
- Full Parameter Tree – Occasionally used in ASW-guided troubleshooting (e.g., saving/loading parameter files). Users should never modify parameters unless instructed by ASW support.

Additional Resources

For in-depth, self-paced learning:

- ArduPilot Mission Planner Documentation: <https://ardupilot.org/planner>
- ArduPilot Multicopter Documentation: <https://ardupilot.org/copter>
- ArduPilot Forums and Q&A: <https://discuss.ardupilot.org>

ASW also offers in-person mission planning training courses for customers who require more comprehensive instruction or hands-on practice. Please contact us for further information.

Emergency Procedures

ASW drones incorporate several built-in failsafes, which are automatically triggered responses to specific system conditions such as low battery, loss of link, or loss of GPS. These protections are designed to reduce risk by taking predefined actions (for example, returning to launch on a low battery or C2-link loss, or transitioning to land mode if GPS errors become excessive). Many failsafe actions are user-configurable within ArduPilot, but ASW recommends consulting with us before changing any failsafe settings to ensure your configuration remains safe and appropriate for your aircraft and mission.

Failsafes are not a substitute for operator-defined emergency procedures (EPs). Every operation is unique, and it is the operator's responsibility to establish, brief, and rehearse mission-appropriate EPs before flight. At a minimum, operators should ensure they have clear plans for responding to conditions commonly encountered in multirotor operations. These typically include: how to react to a critically low battery (e.g., recognizing warnings, assessing whether an in-place landing is safe, and knowing when a safety pilot should intervene); how to respond to a loss of power such as a motor failure or sudden loss of thrust (including immediate communication, attempts to regain control, and executing the safest possible landing if control returns); how to handle a loss of GPS, whether the aircraft is within visual line of sight or beyond it (including transitioning to a non-GPS mode such as AltHold and selecting a safe landing or ditch point as needed); and how to react to a manned aircraft incursion (which generally involves immediately descending or diverting the drone to avoid air traffic and landing if the area cannot be cleared in a timely manner). These scenarios represent common categories of in-flight emergencies, and operators should adapt them to the specifics of their mission environment, airspace, and team structure. Regardless of the situation, effective emergency response requires:

- Positive identification of the event
- Clear and immediate communication among the flight crew
- Awareness of the aircraft's location relative to people, property, and airspace
- Decisive action consistent with the mission's pre-briefed procedures

Operators are responsible for developing EPs suitable for their operational context and ensuring that all personnel involved in flight operations understand and are prepared to execute them.

In Shop - Preflight Checklist

Suggested for Convenience

Item(s)	Action(s)	
Main Battery Pack(s)	Charged, Packed	
Hand Controller	Packed	
Ground Control Station (GCS) Computer	Charged	
	Maps Prefetched - <i>if required</i>	
	Packed	
GCS Telemetry (C2) Modem	Packed	
Mission PreBrief	Conducted	
Aircraft <i>frame, landing gear (LG), propellers, arms, arm screws</i>	Visually Inspected	
	Maintenance Logs Checked	
	Packed	
Field AC Power - <i>if applicable</i>	Packed	
Tools - <i>LG, arms, terminal blocks, other.</i>	Packed	
Spares - <i>prop pairs, arms, LG, other</i>	Packed	
Payload Specific Equipment - <i>if applicable</i>	Prepared, Charged, Packed - <i>as applicable</i>	

Assembly - Preflight Checklist

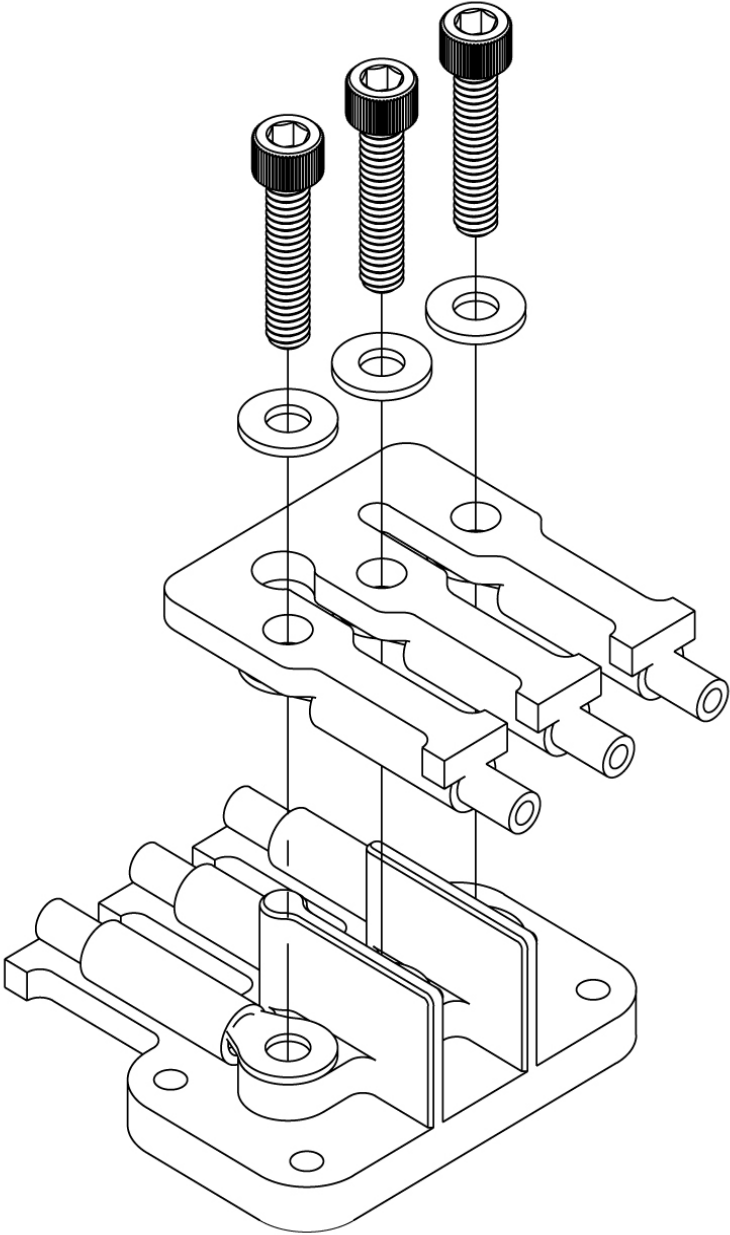

Assembly - Preflight Checklist

Run At First Flight of Each Day or Flying Session

Item(s)	Action(s)	
Main Battery Pack(s)	Mounted, Secured with Rubber Tie-Downs	
Landing Gear	Attached, Screws Tightened	
	Safety Pinned – <i>NA for ILM Legacy</i>	
Arms - <i>Critical</i> 	Attached, Screws Tightened	
	Terminals Connected, Flat, All 3 Bolts Tight	
Aircraft Antennas	Checked, Secured	
Propellers	Rotation Directions Correct	
Motors	Spin Freely	
	Mount Screws Secure (<i>torque indicator</i>)	
Frame	Critical Hardware Secure (<i>torque indicator</i>)	
Payload – <i>if applicable</i>	Mounted, Secured, Prepared	



Safety Note: When connecting arm terminals, ensure that the included washers are positioned below the bolt heads, but above the arm-side fiberglass plate as shown.

Pre-Launch & Launch – Preflight Checklist

Power On

Run Every Flight – Safety Critical



Item(s)	Action(s)	
GCS Computer	Powered On, AC Power if Available	
GCS C2 Modem	Connected to GCS	
Hand Controller <i>Reference Handbook for Initial Config</i>	Connected to GCS, Powered On	
	Enabled	
Props	Open and Main Bolts Secure (torque indicator)	
	Secured to Motors	
Aircraft	Batteries Connected, Autopilot Initialized	

Pre-Launch & Launch – Preflight Checklist

Pre-Launch

Run Every Flight – Safety Critical



Item(s)	Action(s)	
Remote ID	Operator ID Set	
GCS Software	Connected to Aircraft	
Autopilot	Confirm Disarmed	
Mission Profile	Takeoff Waypoint Set	
	Elevations Checked	
	Read from Aircraft, Displayed Correctly	
C2 Link Strength	Minimum Loss	
Flight Modes	Respond to Hand Controller	
GPS	3D Fix, HDOP Below 2.0	
HUD Attitude	Correctly Responds to Motion	
Compass	Full or Acceptable for Planned Flight	
Battery Voltage	Prepped, Working Correctly	
Payload - <i>if applicable</i>	Prepared, Working Correctly	
Aircraft	In Desired Takeoff Location, Area Cleared	

Pre-Launch & Launch - Preflight Checklist

Final Launch Items

Run Every Flight - Safety Critical



Item(s)	Action(s)	
Launch Area and Airspace	Clear, Safe	
Mode	Set to Auto	
Final HUD Checks	HUD Altitude Near Zero	
	HUD Mode Displays Auto	
	HUD Active Waypoint Displays 1	
	HUD Waypoint Distance Near Zero	
Hand Controller	Loiter Mode, Throttle Stick Down	
Autopilot	Armed, All Motors Spinning	
Hand Controller	Auto Mode	
	Throttle to Neutral - Aircraft will Takeoff	
Launch	Time Noted, Complete	

Specs & Maintenance



Understanding the aircraft's maximum operating specifications is critical to ensuring safe and reliable performance.

This section outlines the defined limits for weight, altitude, temperature, and other key parameters that must be observed during operation. Exceeding these specifications can lead to unsafe flight conditions, a reduction in system reliability, and may impact warranty coverage.

Following the specifications, you will find the recommended maintenance table. These intervals are designed to help you keep your aircraft in peak condition, minimize downtime, and extend service life. Use this table as a reference for routine inspections and part replacement schedules to ensure consistent mission readiness.

ILM Legacy Quadcopter - Specs

Feature	Details
Max Operating Payload*	5 kg
Max Flight Time*	43 Minutes
Max Forward Flight Range*	~26 km
Service Ceiling	3600m MSL
Max Takeoff Weight (MTOW)*	12 kg
Payload Mounting	Various
Battery Configuration	Single LiPo pack

Operational Limits:

Operating near these limits may require additional tuning or integration support. Always consult ASW before flying at or near maximum published specifications. This document is provided for informational purposes only and does not constitute a warranty, commitment, or guarantee of performance.

Suggested Standard Operation Zone in Green*

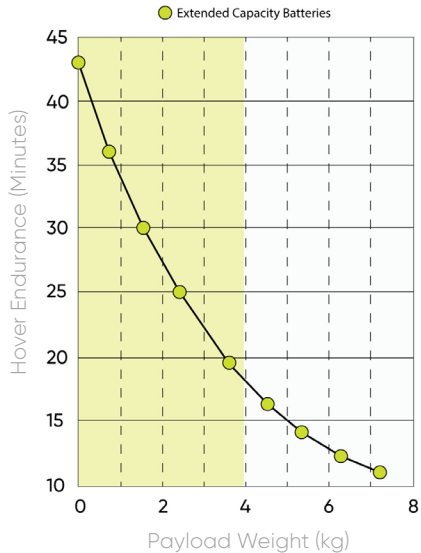

*Performance values are nominal and based on standard test conditions. Actual results may vary depending on payload configuration, environmental factors, and operational practices. Maximum payload and MTOW values represent the upper edge of the tested flight envelope and should not be considered standard operating parameters.

HLM Quadcopter - Specs

Feature	Details
Max Operating Payload*	20 kg
Max Flight Time*	65 Minutes w/Extended Capacity Batteries
Max Forward Flight Range*	~41 km w/Extended Capacity Batteries
Service Ceiling	3600m MSL
Max Takeoff Weight (MTOW)*	42 kg
Payload Mounting	Standard Slot Patterns, Optional Rails
Battery Configuration	Dual LiPo packs (standard or extended range options)

Operational Limits:

Operating near these limits may require additional tuning or integration support. Always consult ASW before flying at or near maximum published specifications. This document is provided for informational purposes only and does not constitute a warranty, commitment, or guarantee of performance.

Suggested Standard Operation Zone in Green*

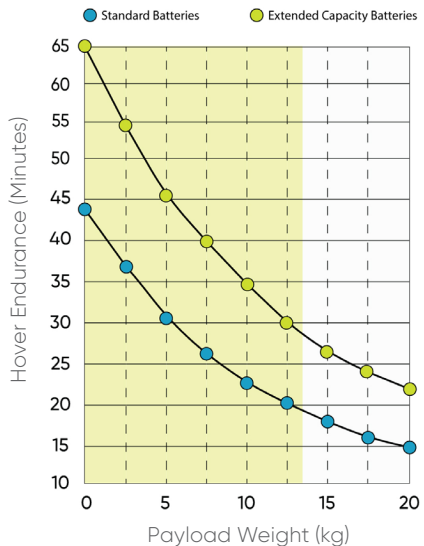

*Performance values are nominal and based on standard test conditions. Actual results may vary depending on payload configuration, environmental factors, and operational practices. Maximum payload and MTOW values represent the upper edge of the tested flight envelope and should not be considered standard operating parameters.

HLM Hexacopter - Specs

Feature	Details
Max Operating Payload*	30 kg
Max Flight Time*	60 Minutes w/Extended Capacity Batteries
Max Forward Flight Range*	~37 km w/Extended Capacity Batteries
Service Ceiling	3600m MSL
Max Takeoff Weight (MTOW)*	55 kg
Payload Mounting	Standard Slot Patterns, Optional Rails
Battery Configuration	Dual LiPo packs (standard or extended range options)

Operational Limits:

Operating near these limits may require additional tuning or integration support. Always consult ASW before flying at or near maximum published specifications. This document is provided for informational purposes only and does not constitute a warranty, commitment, or guarantee of performance.

Suggested Standard Operation Zone in Green*

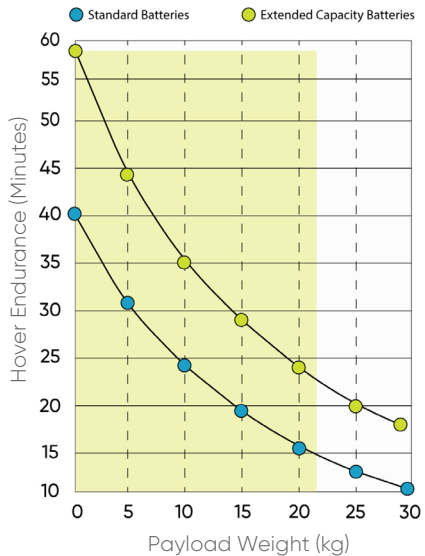

*Performance values are nominal and based on standard test conditions. Actual results may vary depending on payload configuration, environmental factors, and operational practices. Maximum payload and MTOW values represent the upper edge of the tested flight envelope and should not be considered standard operating parameters.

HLM Octocopter - Specs

Feature	Details
Max Operating Payload*	35 kg+
Max Flight Time*	70 Minutes w/Extended Capacity Batteries
Max Forward Flight Range*	~47 km w/Extended Capacity Batteries
Service Ceiling	3600m MSL
Max Takeoff Weight (MTOW)*	76 kg+
Payload Mounting	Standard Slot Patterns, Optional Rails
Battery Configuration	Quad LiPo packs (standard or extended range options)

Operational Limits:

Operating near these limits may require additional tuning or integration support. Always consult ASW before flying at or near maximum published specifications. This document is provided for informational purposes only and does not constitute a warranty, commitment, or guarantee of performance.

Suggested Standard Operation Zone in Green*

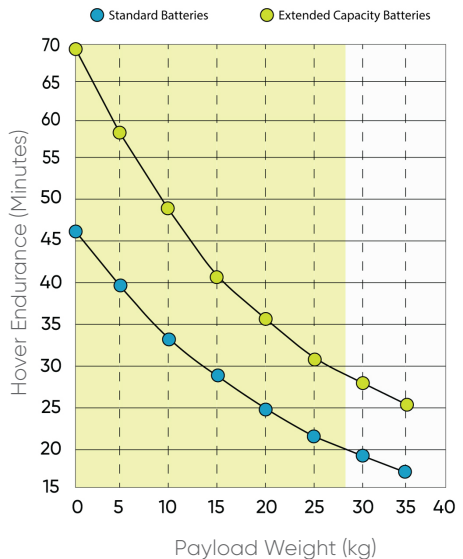

*Performance values are nominal and based on standard test conditions. Actual results may vary depending on payload configuration, environmental factors, and operational practices. Maximum payload and MTOW values represent the upper edge of the tested flight envelope and should not be considered standard operating parameters.

Maintenance Intervals - All Aircraft

		Frequency				
Note: See Below	Item	Every Flight	~300 Hours	~1500 Hours	Every 1-2 Weeks	Every 3-6 Months
Airframe	A	Preflight Inspection	X			
	B	Replace Motor Bearings (Inspect Main Shaft)		X		
	C	ESC Inspection		X		
	D	ESC Replacement			X	
Batteries	E	Physical Inspection	X			
	F	Storage Charge			X	
	G	Cycle Charge				X

A: Majority of drone maintenance is inspection-based and preventative. Assembly and Prelaunch checklists are designed to encompass most routine maintenance concerns.

B: Procedure can be performed by trained technician or customer. Repair not warranted unless performed by OEM.

C: Optional unless UAS subject to severe duty service (more than 50% of flights at greater than 50% throttle). Data-only procedure can be performed by trained technician, customer, or OEM.

D: Only offered through OEM.

E: Visual inspection for exterior damage, excessive "puffing," damaged leads, or damaged wires.

F: Using a "smart" balancing charger, return all packs to a storage charge level (~3.75 V/cell; 45V for HLM packs; 22.5v for ILM Legacy packs).

G: See Page 21

Supplements



The supplements provided will point you toward reliable solutions that meet ASW operational standards.

This section provides an overview of approved accessories, recommended supplements, and software tools that support ASW systems in the field. Here you will also find direct links to trusted vendors, integration partners, and additional resources that can extend the capabilities of your aircraft.

Herelink

The Cubepilot Herelink integrated controller and video transmission system is an **alternate option** for telemetry and hand control of ASW aircraft. This is considered non-standard equipment and replaces factory default command and control equipment only when purchased as such by the original customer. As a Cubepilot licensed partner and reseller, ASW is responsible for supporting the original customer on hardware warranty claims (defects in materials or workmanship). Except in situations where custom training has been coordinated, ASW support does not extend to training and familiarization with operation of the Herelink or installed QGroundControl software. It is the responsibility of the operator to become familiar with operation and navigation of the Herelink.

Online resources for Herelink operation can be found here:

<https://docs.cubepilot.org/>

<https://docs.qgroundcontrol.com/master/en/>

Unless otherwise specified the diagram below indicates the typical factory configuration for Herelink equipped ASW aircraft. Note that individual customer setups may differ based on unique requirements.

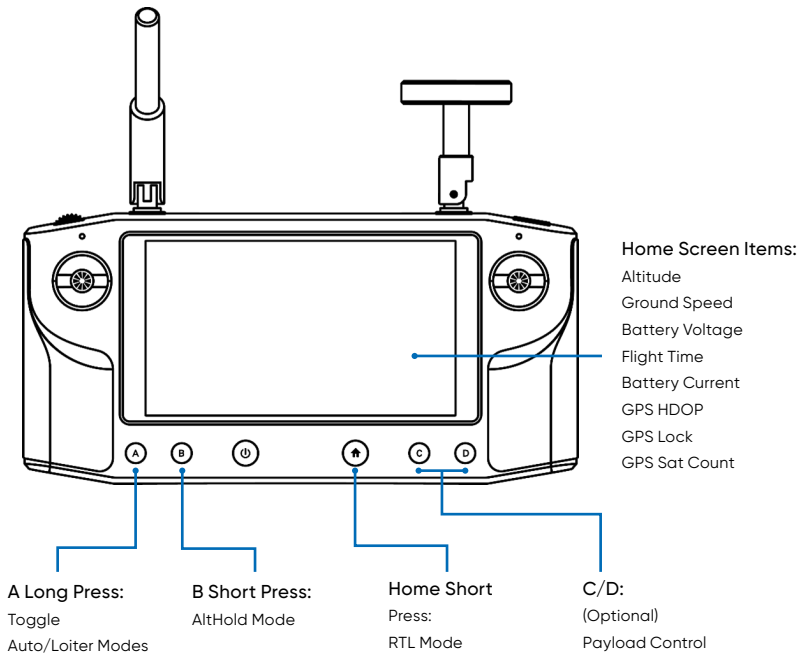

Radio Control System

In addition to the default controller configuration, ASW supports custom installations of various alternatives. For customers who have opted to replace the hand controller with a traditional 2.4GHz RC transmitter for manual safety pilot controls, please review the following:

Traditional RC transmitters will be installed in place of the default USB hand controller. **The default hand controller will not be included in the shipment unless purchased separately.** Unless otherwise specified the notes below indicate the typical factory configuration for RC equipped ASW aircraft.

Note: Individual customer setups may differ based on unique requirements.

- RC transmitters will typically be setup in a "Mode 2" configuration.
- The right joystick will be used for roll (right, left) and pitch (forward, back).
- The left joystick will be used for yaw (left, right) and throttle (forward, back).
- Please note that the function of "Throttle" varies by aircraft mode.
- Three modes (AltHold, Loiter, and Auto) will be assigned to a 3-position toggle switch, typically near the operators left index finger.

All other switches and channels will remain unassigned unless associated with custom engineering work.

Daughterboards



The ASW HLM avionics carrier board serves as an integrated solution for most flight control functions needed by the drone. The carrier takes advantage of a “Daughterboard” architecture, where critical functions are broken out into easily-swappable PCBs allowing for maximum build flexibility. The carrier contains the following three daughterboard locations:

Telemetry:

This location hosts the primary telemetry modem used for command and control of the drone. By default this is configured with an RFDesign 900 series modem, but ASW offers additional options, to include the popular HereLink all-in-one controller.

LTE/Compute:

This location primarily serves for customers taking advantage of ASW’s LTE command and control offerings for unlimited range and remote access functions. This can be installed alongside or instead of standard telemetry options.

Customer:

Located on top of the carrier for convenient access, the customer daughterboard location allows for clean, wire-free installations of any customer peripheral requiring serial communication with the flight controller. The most popular use-case for this location is installation of companion computers, typically used for advanced computational functions desired by the customer to happen separate from the flight controller. This allows for maximum safety and more powerful computing options.

Coming Soon:

Coming soon: ASW will begin offering a small number of our more popularly requested companion daughterboards. This will include Raspberry Pi™ compute modules and various Nvidia™ options. Please contact ASW for integration drawings, pinouts, electrical specifications, and additional information.

Resources - Arducopter (Software)

Ardupilot - Main Wiki

Main Wiki page dedicated to Ardupilot and its many features.

<https://ardupilot.org/ardupilot/index.html>



Ardupilot - Copter Wiki

Copter specific Wiki resources for reference and education.

<https://ardupilot.org/copter/>

Ardupilot Community Forum

Copter software and configuration user support discussion.

<https://discuss.ardupilot.org/>



Ardupilot Codebase

ArduPilot development team codebase and repositories.

<https://github.com/ArduPilot>

Resources - CubePilot (Hardware)

CubePilot - Hardware Overview

Page dedicated to the CubePilot product and its many features.

<https://cubepilot.org>

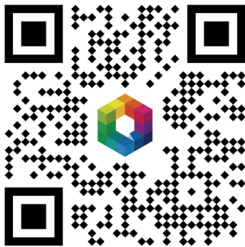

CubePilot - User Manuals

Cubepilot specific resources for reference and education.

<https://docs.cubepilot.org/user-guides>

CubePilot Community Forum

CubePilot hardware and configuration user support forum.

<https://discuss.cubepilot.org/>

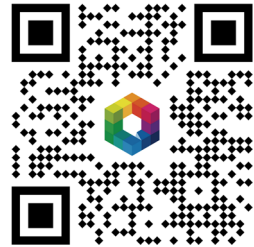

Resources - Mission Planner (GCS)

Mission Planner - Main Wiki

Mission Planner, created by Michael Osborne, does a lot more than its name. Explore some of its features.

<https://ardupilot.org/planner/index.html>



Mission Planner - Code Base

Cubepilot specific resources for reference and education.

<https://github.com/ArduPilot/MissionPlanner>

Resources - Aero Systems West (ASW)

Docs - Visual Guides

For visual guides and additional references to technical information.

<https://aerosystemswest.com/docs/>



ASW - Main Website

For general and technical information related to our aircraft, additional products and more.

Admin - Version Control

Change Log:

Revision	Date Issued	Changes Made	Pages
2.0	December 4th, 2025	Document Published	1-80
2.1	March 18th, 2026	Add import/export instructions - XML file location updated	16, 18
2.2	April 21st, 2026	Remote ID Operator-ID procedure updated for ASW Remote ID Tool	27

References:

- HLM/ILM Legacy Checklist Supplement* - v19Sep25.9 - Cube,AC4.x,MP1.3.x,KDE,RID - Please reference Quick-Start Guides at: <https://aerosystemswest.com/docs/>

Contact - ASW General Support

For all inquiries—including technical support, maintenance questions, warranty claims, replacement parts, and sales—please contact Aero Systems West (ASW) directly. Our team is available to assist with product registration, mission integration, troubleshooting, and service coordination.

Mailing Address:

Head Office
Aero Systems West, Inc.
13025 Murphy Ave, San Martin 95046
California, USA

Email: info@aerosystemswest.com

Phone: +1 (408) 599-2791

Website: aerosystemswest.com

For warranty-related matters, please retain a copy of your proof of purchase and aircraft serial number when contacting ASW.



ASW - Official Website

For general support and additional information related to our aircraft, additional products and more.

<https://aerosystemswest.com/>

Additional Supplements

ADDITIONAL
SUPPLEMENTS
HERE

Additional Supplements

ADDITIONAL
SUPPLEMENTS
HERE